

Wood ceilings & coverings

**LAMELLA**  
**300 - 301**  
system

 **CBI**  
EUROPE  
HI-TECH INTERIORS



# WOOD LAMELLA 300 SYSTEM

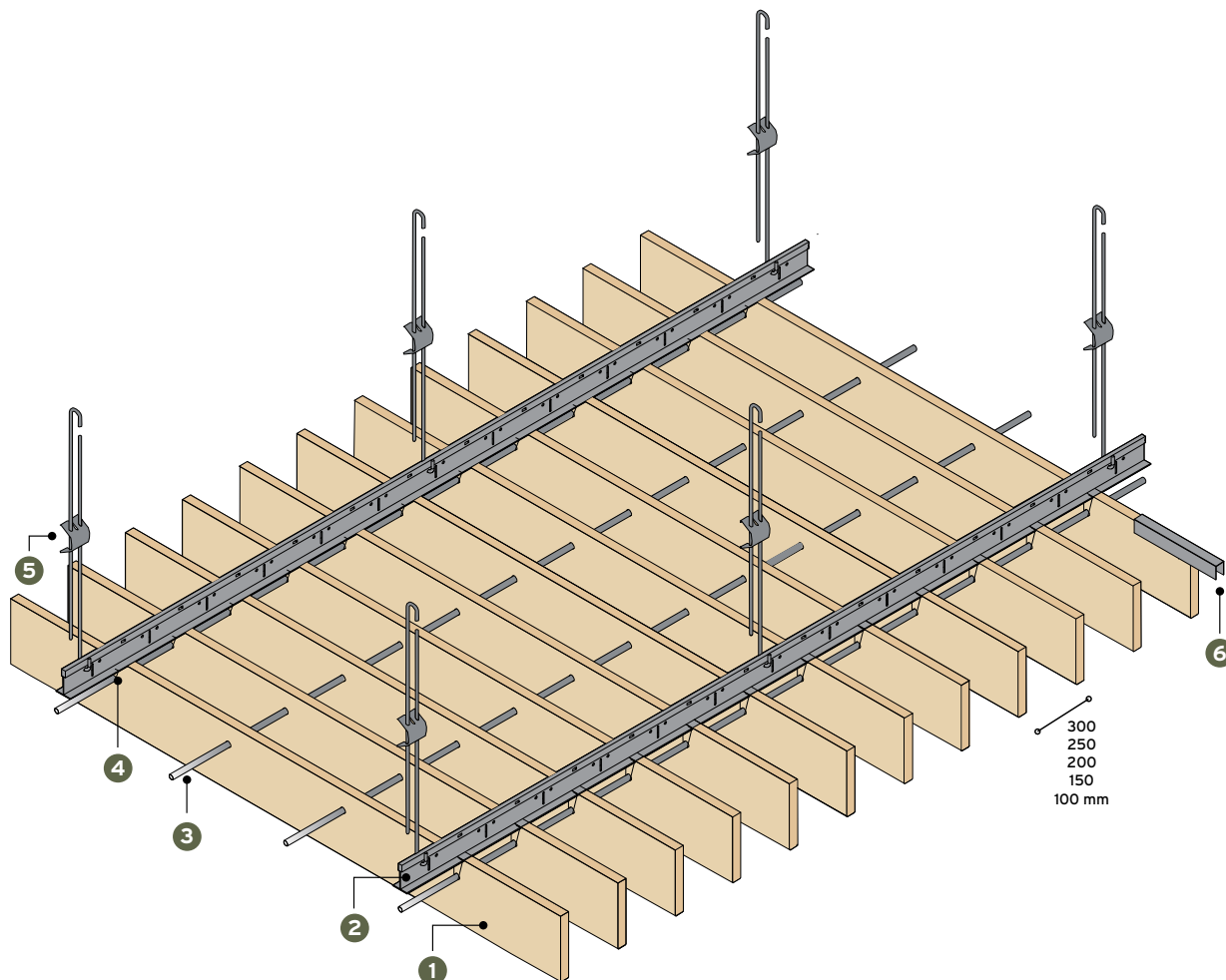

## SLAT LAMELLA

dimension  
H 100 / 150 / 200 mm  
L 1200 / 1800

type  
MELAMINE  
REAL VENEER

## GRID SYSTEM STRUTTURA

· CWG

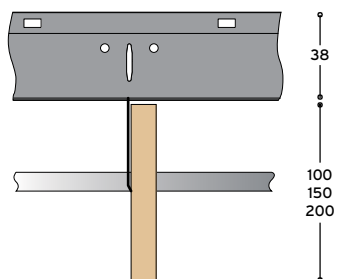

<b>1</b>	<b>2</b>	<b>3</b>	<b>4</b>	<b>5</b>	<b>6</b>
slat lamella H 100/150 /200 mm	<b>P 3700 N</b> main runner profilo portante 32x36x4000 mm	<b>TU 08</b> aluminium tube tubolare in alluminio Ø 8 mm	<b>SP 39</b> spring molla	<b>SOR</b> suspension sospensione	<b>SPB1</b> connector for slat connettore per lamella

# WOOD LAMELLA 301 SYSTEM

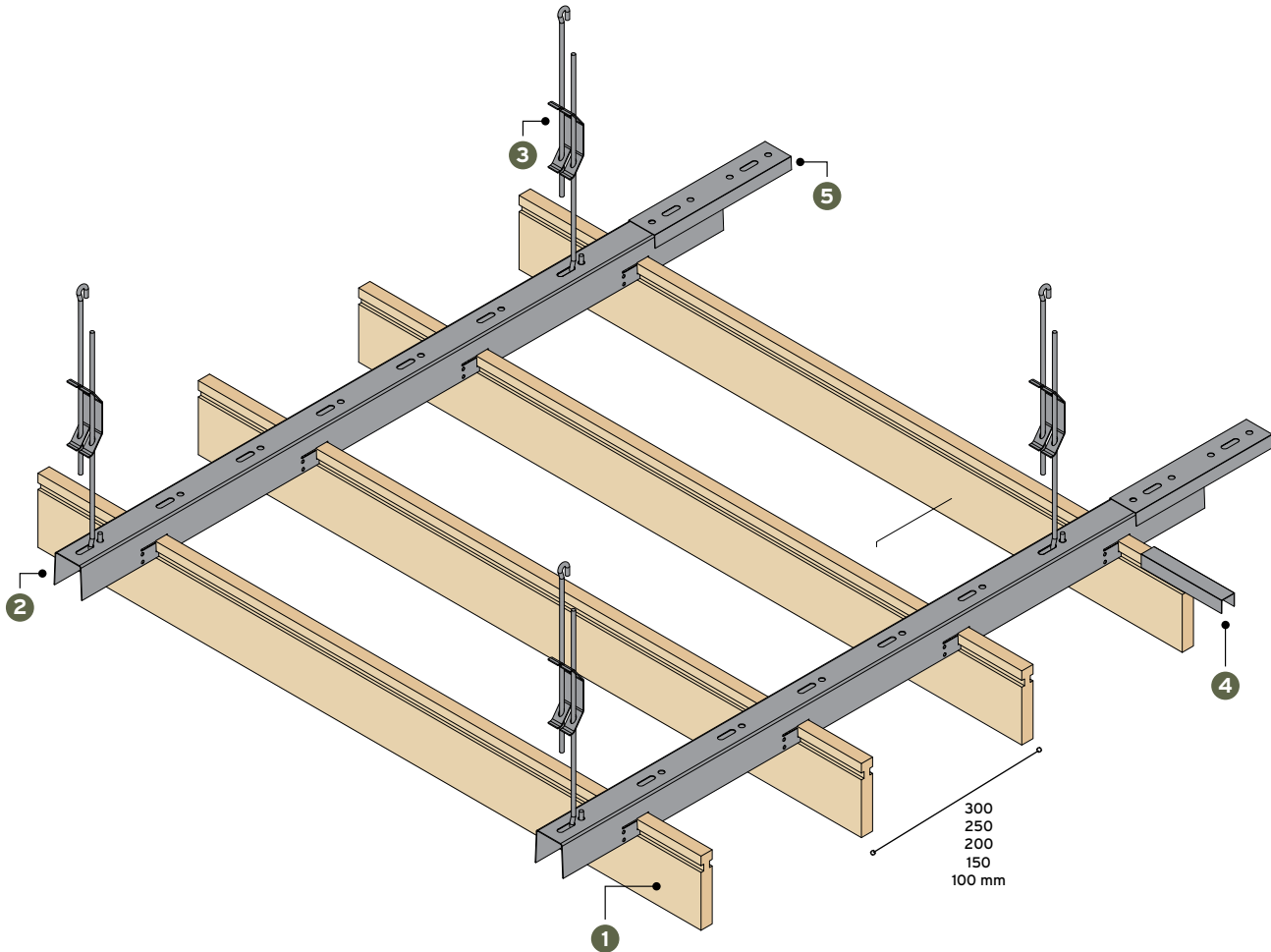

## SLAT LAMELLA

dimension  
H 100 / 150 / 200 mm  
L 1200 / 1800

type  
MELAMINE  
REAL VENEER

## GRID SYSTEM STRUTTURA

· CWF

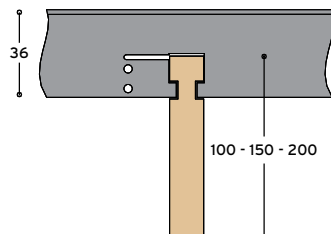

<b>1</b>	<b>2</b>	<b>3</b>	<b>4</b>	<b>5</b>
slat lamella H100/150/200 mm	T 91/N main runner profilo portante 32x36x4000 mm	SOR suspension sospensione	SP81 connector for slat connettore per lamella	CN81 connector for main runner connettore per profilo portante

## TYPE OF PANELS

### LAMELLA - MDF HIGH DENSITY

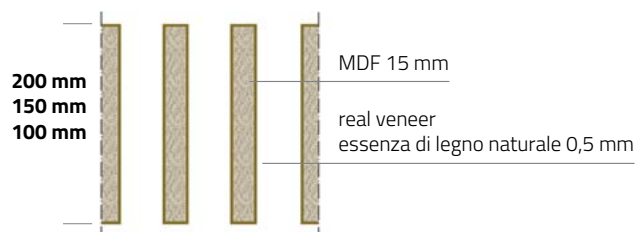
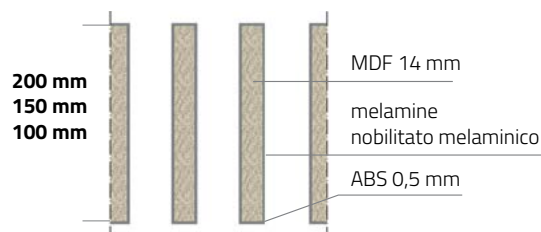

#### MDF HIGH DENSITY

Internal bond · Resistenza allo strappo	EN 319	0,65 / 1,1 N/mm <sup>2</sup>
C.R.F.	EN 310	22 / 35,1 N/mm <sup>2</sup>
M.O.E.	EN 310	2500 3180 N/mm <sup>2</sup>
Thickness swelling 24H (max) · Rigonfiamento 24H (max)	EN 317	15,0 / 12,3 %
Surface soundness · Strappo superficiale	EN 311	1,2 / 1,8 N/mm <sup>2</sup>
MDF Density · Densità	EN 323	780 Kg/m <sup>3</sup> +/- 5%
Thickness Tolerance · Tolleranza di spessore	EN 324-1	+/- 0,2 mm
Length and width tolerance · Tolleranza lunghezza e larghezza	EN 324-1	+/- 0,3 mm
Squareness · Squadro	EN 324-2	+/- 0,3 mm
Moisture content · Umidità	EN 322	4% - 11%
Grit content · Contenuto in silice	ISO 3340	< 0,05%
Formaldehyde · Formaldeide	EN 120	< 9 mg / 100 g
<b>Fire reaction class · Classe di reazione al fuoco</b>		<b>B s<sub>2</sub> d<sub>0</sub></b>

## MODULARITY

### LAMELLA

#### rectangular

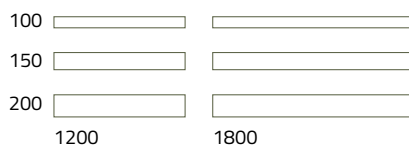

OTHER DIMENSION AVAILABLE ON REQUEST

## FINISHES

### MELAMINE

> LAMELLA



oak rock white



elm tafira



ash tree supremo



oak bruges



walnut athens



white

### REAL VENEER

> LAMELLA



maple



wengè



beech



cherry



zebrano



ash tree



walnut 1



walnut 2



mahogany



oak

The colour card shown on this page is purely for information purposes; please request samples. Please contact CBI Europe's Technical Office for special colour re-

quirements which will be supplied only for orders of at least 800 sq.m. Wood system accessories are finished in aluminium or wood.

# WOOD CEILINGS & COVERINGS: technical perfection, 100% made in Italy.

Modern, welcoming workplaces, free from noise pollution, where the warmth of natural wood is complemented by stylish, clean lines. Slats and panels set new standards in style for public offices and community spaces.

Modular elements standard or custom made, resistant, durable, easy to handle, simple and quick to install, inspected, certified, eco-friendly. They can be installed in any environment thanks to the architectural elements of great aesthetic versatility.



**AESTETICH VERSATILITY**



**CONFIGURABILITY**

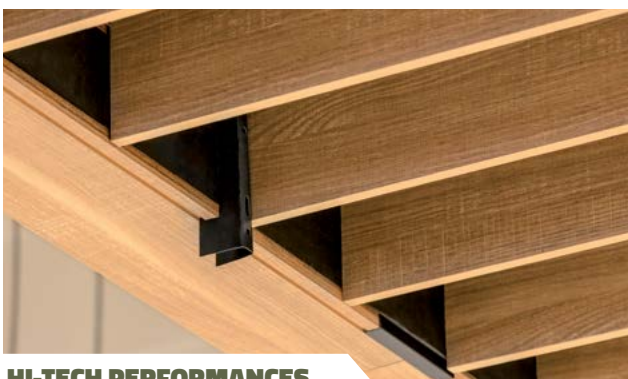

**HI-TECH PERFORMANCES**

## Why

- **MODERN AESTHETICS FOR ENVIRONMENTS WITH A WELCOMING AND NATURAL ATMOSPHERE.**
- **EXCLUSIVE IN-LINE ASSEMBLY STRUCTURE: SIMPLE, QUICK TO INSTALL, WITH CUSTOMIZABLE GAP ON REQUEST.**
- **SEISMIC SAFETY.**

## Where

**AUDITORIUMS, THEATRES, AIRPORTS, CONFERENCE ROOMS, OFFICES, PUBLIC SPACES AND ALL ENVIRONMENTS THAT REQUIRE SAFETY, EFFECTIVE NOISE CONTROL AND ELEGANT INTERIOR DESIGN.**

## Benefit

- **ACHIEVING FLEXIBLE, COMFORTABLE, CONTEMPORARY AND RESPONSIBLE INTERIORS.**
- **OBTAINING POINTS FOR LEED CERTIFICATION.**
- **SOUNDPROOFED ENVIRONMENTS.**
- **SPEEDING UP CONSTRUCTION.**
- **CONTAINING COSTS OF LABOUR AND MAINTENANCE.**
- **STRUCTURES 100% INSPECTABLE.**
- **INTEGRATION WITH ADVANCED CLIMATE CONTROL, DOMOTICS AND LIGHTING.**
- **PRECISE BUDGETING.**





## FIRE REACTION

CBI Europe works hard to ensure the safety of the environments set up with its products. Research and tests allow us to obtain a constant evolution of quality. Certifications are provided on request.



## FASTNESS

Our systems are designed to guarantee rapid installation, speeding up the laying phases and respecting all the requirements of planarity and orthogonality.



## ACOUSTIC ABSORPTION

All systems are designed to offer excellent sound absorption performance, specific to the type of environment, safety and aesthetic results. Certifications are provided on request.



## LEED CERTIFICATION

All products are manufactured in certified and constantly monitored processes to guarantee the highest standards of quality and safety.



## ANTI-SEISMIC

The systems guarantee the application of all good safety practices in the construction and development of dedicated projects. Upon request, they can be supplied with an anti-seismic reports, which indicate suitable bracing.



## INTEGRATED ACCESSORIES

The system can be fitted with accessories such as lighting units, ventilation vents, smoke detectors, sprinklers and suspended signage.



## RECOMMENDATIONS FOR INSTALLATION

Slight differences in colour and shade between one panel and another are due to natural variations in the wood veneers. To obtain the most pleasing aesthetic effect, we recommend that you lay the panels out before deciding on their final arrangement. It is also good idea to order an extra number of panels to allow for future replacements, since shades, colours and grain can vary from one batch to another. All 'CBI Sound Wood Panels' must only be installed in indoor environments when the building maintained at a constant temperature.

Wood System panels should be removed from their packaging in the place of installation 48 hours before installing the ceiling or wall, so that they can assume the humidity of the environment. We recommend switching on the air conditioning in the environment at least 24 hours before starting installation. The installation environment should have temperature no lower than 15° and a relative humidity between 35% and 55% before work starts.



## HYGIENE AND MAINTENANCE

Wood System panels are easy to maintain and require no special maintenance. To clean, simply wipe with a dry cloth. Panels should not be exposed to direct sunlight: like all natural materials, wood tends to change colour when exposed to UV rays. The polyacrylate treatment of the panels tends to reduce this effect. Remember that water and humidity will damage the veneering.

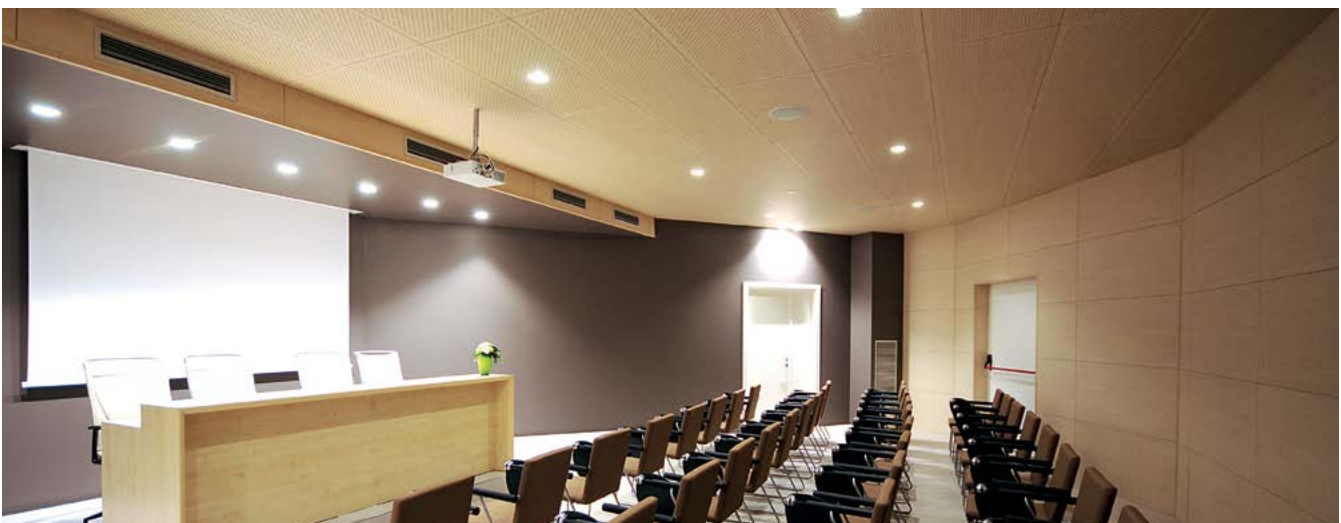

CBI EUROPE Via Mons. A.O. Romero, 14 · 60027 Osimo (AN) Italy  
T +39 071 71 08 688 · fax +39 071 71 08 63 · info@cbi-europe.com · www.cbi-europe.com

